

- S1700 - 1.70x1.70 m
- S2050 - 2.05x2.05 m

Torre/Reazioni – Masts/Reactions – Mat/Réactions – Maste/Eckdrücke – Mástil/Reacciones – Tramo/Reacções

S1700

15 m → 60 m

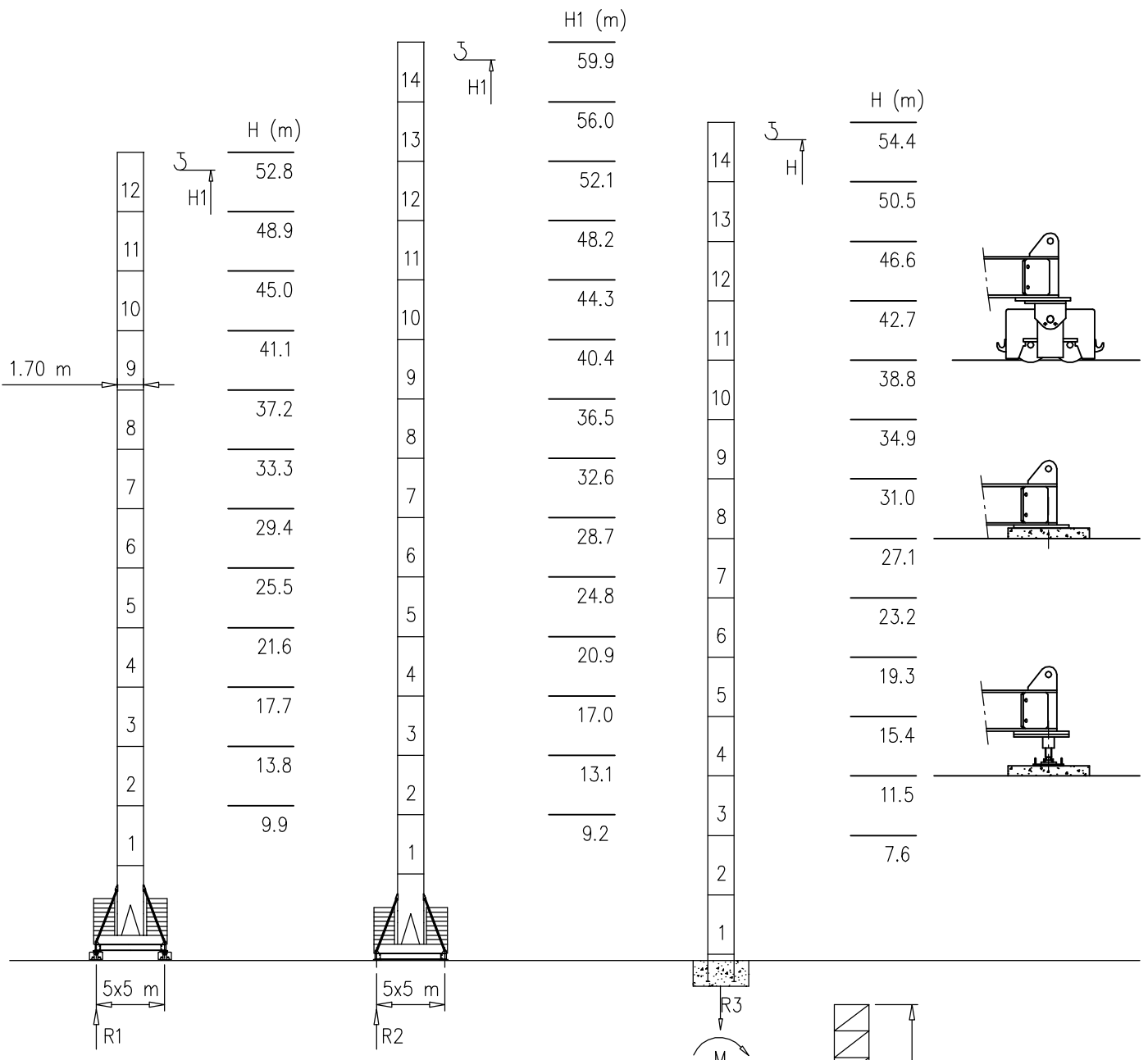

H=46–56 m		H=0–45 m	
R1	106 t	R1	89 t
R2	106 t	R2	88 t
R3	95 t	R3	74 t
M	336 tm	M	194 tm

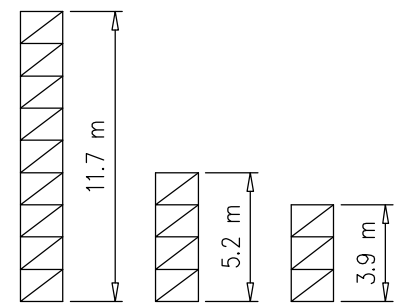

Peso zavorra – Ballast weight – Poids du lest – Ballastgewicht – Peso de lastre

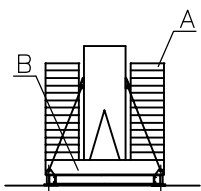

H	n°	Tot.
0–35 m	2B+14A	63600 kg
36–45 m	2B+16A	70600 kg
46–58 m	2B+26A	105600 kg

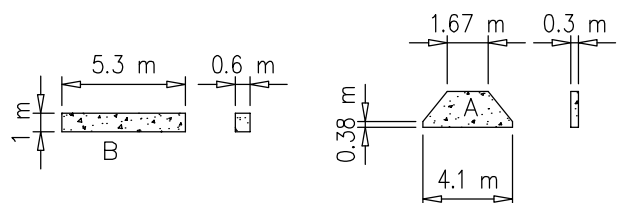

Torre/Reazioni – Masts/Reactions – Mat/Réactions – Maste/Eckdrücke – Măstil/Reacciones – Tramo/Reacções

S2050

 15 m \rightarrow 60 m

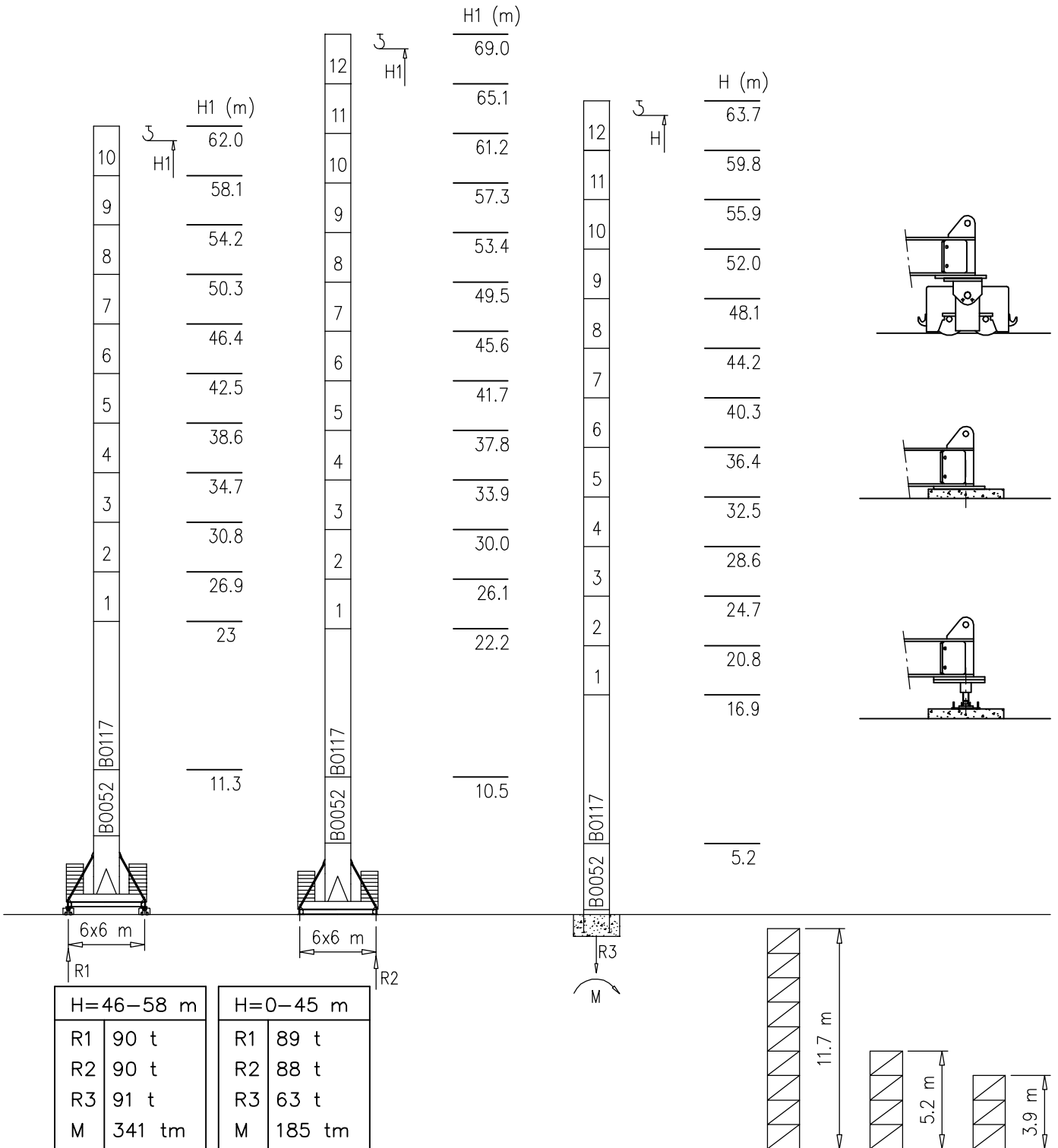



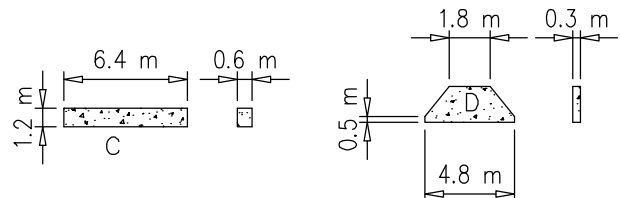
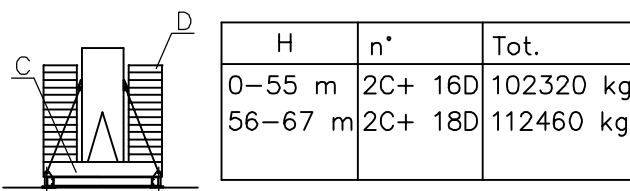





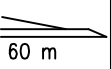

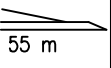

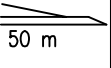

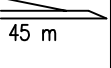

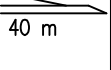

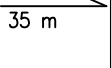
Peso zavorra – Ballast weight – Poids du lest – Ballastgewicht – Peso de lastre

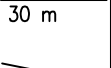

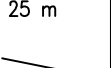

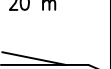

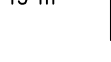



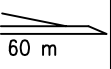

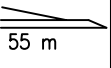

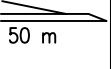

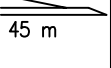

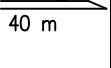

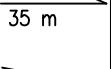
Curve di carico – Courbes de charges – Load diagrams – LastKurven – Curvas de cargas

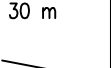
Pmax 3000 kg

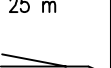
	16800 kg		2.5	33.9	35	40	45	50	55	60	m				
			3000	3000	2890	2460	1900	1660	1460	1300	kg				
	15600 kg		2.5	36.3	40	45	50	55	m						
			3000	3000	2680	2070	1810	1600	kg						
	14400 kg		2.5	37.7	40	45	50	m							
			3000	3000	2500	2170	1900	kg							
	14400 kg		2.5	39.5	40	45	m								
			3000	3000	2960	2300	kg								
	13200 kg		2.5	38.9	40	m									
			3000	3000	2900	kg									
	12000 kg		2.5	35	m										
			3000	3000	kg										
	12000 kg		2.5	30	m										
			3000	3000	kg										
	9600 kg		2.5	25	m										
			3000	3000	kg										
	6000 kg		2.5	20	m										
			3000	3000	kg										
	3600 kg		2.5	15	m										
			3000	3000	kg										

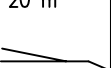
Pmax 6000/3000 kg

	16800 kg		2.5	18.3	20	25	30	35	40	45	50	55	60	m	
			6000	6000	5700	4250	3460	2890	2460	1900	1660	1460	1300	kg	
	15600 kg		2.5	19.6	20	25	30	35	40	45	50	55	m		
			6000	6000	5880	4600	3740	3130	2680	2070	1810	1600	kg		
	14400 kg		2.5	20.35	25	30	35	40	45	50	m				
			6000	6000	4790	3900	3270	2500	2170	1900	kg				
	14400 kg		2.5	21.35	25	30	35	40	45	m					
			6000	6000	5050	4120	3460	2960	2300	kg					
	13200 kg		2.5	21	25	30	35	40	m						
			6000	6000	4950	4040	3390	2900	kg						
	12000 kg		2.5	22.65	25	30	35	m							
			6000	6000	5390	4400	3700	kg							
	12000 kg		2.5	25	30	m									
			6000	6000	4900	kg									
	9600 kg		2.5	25	m										
			6000	6000	kg										
	6000 kg		2.5	20	m										
			6000	6000	kg										
	3600 kg		2.5	15	m										
			6000	6000	kg										









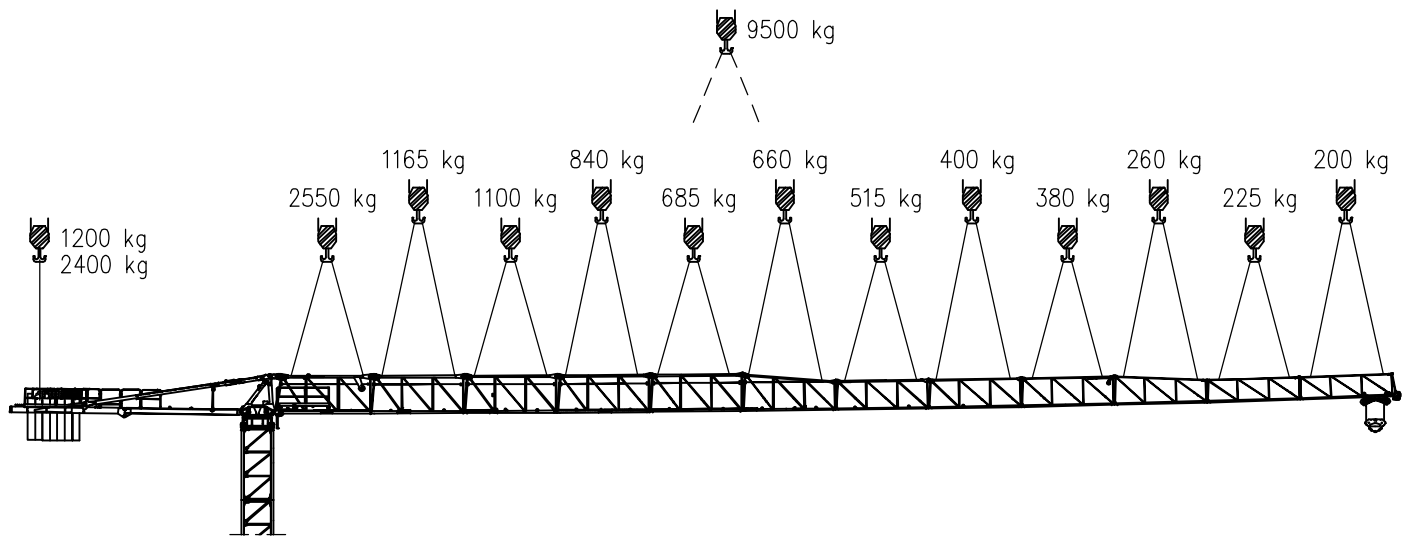
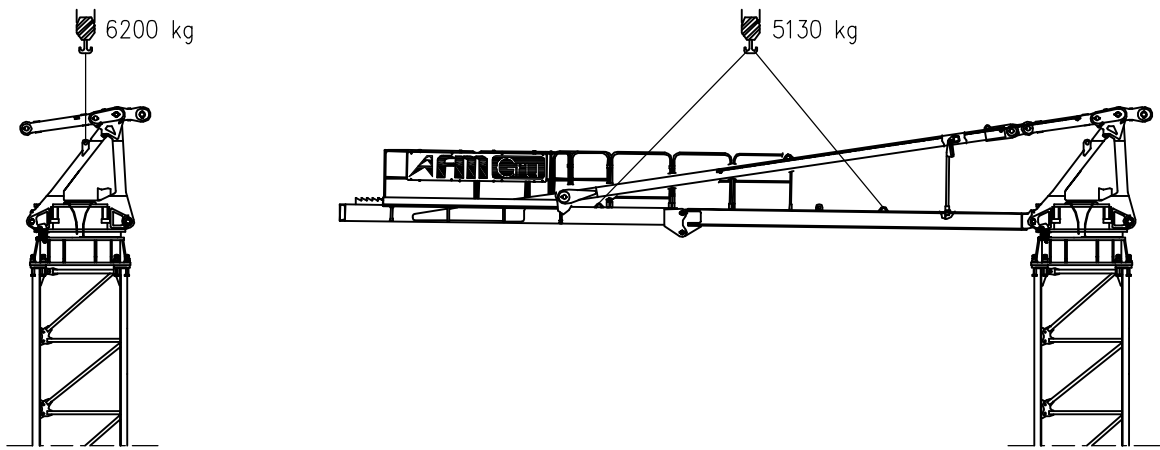
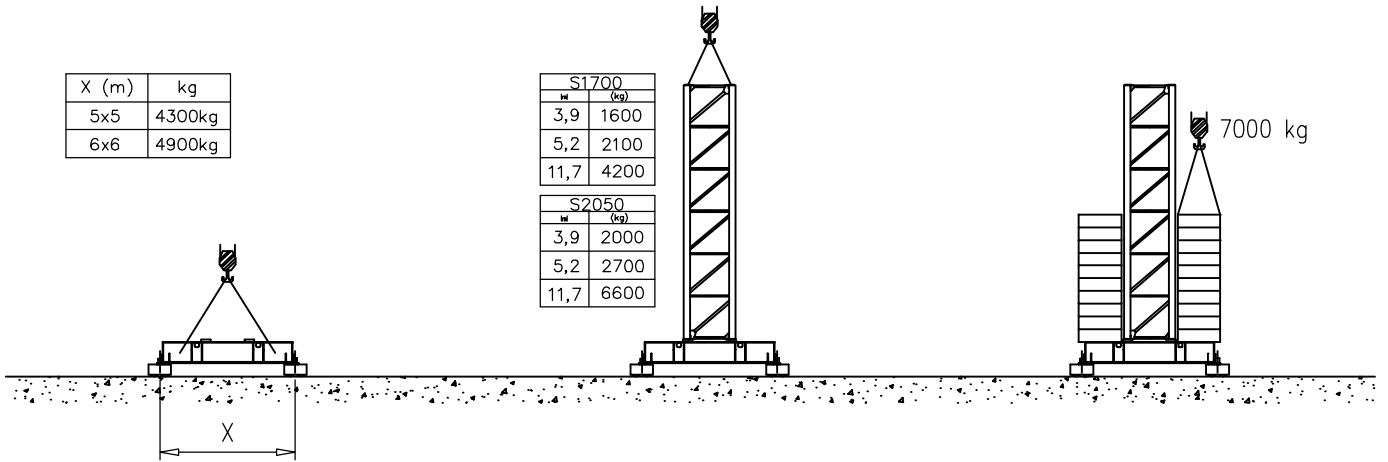

Montaggio – Montage – Erection – Montage – Montaje – Montagem

X (m)	kg
5x5	4300kg
6x6	4900kg

S1700	
H	(kg)
3,9	1600
5,2	2100
11,7	4200

S2050	
H	(kg)
3,9	2000
5,2	2700
11,7	6600

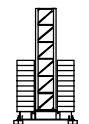

Sollevamento V25.60 Hoisting Levage Heben Elevaciòn Elevaçao			1a	7 m/min	3000 kg	18.5 kW	V25.60 37 kVA					
			2a	18 m/min	3000 kg							
			3a	28 m/min	3000 kg							
			4a	42 m/min	2250 kg							
			5a	56 m/min	1500 kg							
			1a	3.5 m/min	6000 kg							
			2a	9 m/min	6000 kg							
			3a	14 m/min	6000 kg							
			4a	21 m/min	4500 kg							
			5a	28 m/min	3000 kg							
Sollevamento V33.90 Hoisting Levage Heben Elevaciòn Elevaçao			1a	3 m/min	3000 kg	22 kW	V33.90 47 kVA					
			2a	18 m/min	3000 kg							
			3a	34 m/min	3000 kg							
			4a	54 m/min	1800 kg							
			5a	70 m/min	1300 kg							
			6a	90 m/min	500 kg							
			1a	1.5 m/min	6000 kg							
			2a	9 m/min	6000 kg							
			3a	17 m/min	6000 kg							
			4a	27 m/min	3600 kg							
			5a	35 m/min	2600 kg							
			6a	45 m/min	1000 kg							
			Carrello Trolleying Distribution Katzfahren Distribuciòn Distribuiçao					1a	OP 5 m/min	6000 kg	3 kW	Potenza elettrica necessaria Puissance électrique nécessaire Necessary electric power Anschlusswert – Potencia
								2a	25 m/min	6000 kg		
3a	50 m/min	3000 kg										
Rotazione Slewing Orientation Schwenken Orientaciòn Rotaçao			1a	0 → 0.2	giri/min tr/min rp/min	4.4 kW @ 1200rpm n° 2 x 2.2 kW						
			2a	0 → 0.6								
			3a	0 → 0.9								
Traslazione Travelling Translation Kranfahren Traslaciòn Traslaçao			1a	OP 0 → 5	3.7 kW							
			2a	0 → 20								

Rete elettrica – Réseau – Mains supply – Netzstrom – Red – Rede electrica	400V – 50 Hz
---	--------------

 FMgru s.r.l. via Emilia 11-29010 Pontenure PC ITALY tel. 0523/510446 ric.aut. fax 0523/510365 www.fmgru.com e-mail: info@fmgru.com

FEM 1.001 2000/14/CE



Documento commerciale non contrattuale
Per tutte le informazioni tecniche riferirsi
alle corrispondenti istruzioni

Unverbindliches Vertriebsdokument.
Für technische Informationen, siehe die
entsprechenden Anweisungen.

This commercial document is not legally
binding. For any technical information, please
refer to the corresponding instructions.

Documento comercial no contractual
Para cualquier información técnica,
ver la noticia correspondiente.

Code: 15/CA37T40A0		
Ed.	Data	Rev Data
1	10.01.07	1 10.05.08