



















- MONOTRIPHASE -☒ 230/400 V
- TRIPHASE -☒ 400 V

GRU A MONTAGGIO RAPIDO
GRUE A MONTAGE RAPIDE
GRUA DE RAPIDO MONTAJE
GRUA DE MONTAGEM RAPIDA
QUICK SELFRECTING CRANE
HYDRAULISCHER SCHNELLMONTAGEKRAN

Curve di carico – Courbes de charges – Load diagrams – LastKurven – Curvas de cargas

 Triphase	 400 V	3	21.5	m	 Monotriphase	 400 V	3	21.5	m	
		500	500	kg			 230/400V	400	400	kg
 Triphase	 400 V	3	10.5	12	14	16	18	20	22	m
		1500	1500	1270	1050	890	770	670	600	kg
 Triphase	 400 V	3	11.3	12	14	16	18	20	m	
		1500	1500	1400	1160	980	850	750	kg	
 Monotriphase	 400 V	3	12.5	14	16	18	20	22	m	
		1200	1200	1050	890	770	670	600	kg	
 Monotriphase	 230/400V	3	13.6	14	16	18	20	m		
		1200	1200	1160	980	850	750	kg		
 Triphase	 400 V	3	11.3	m	 Monotriphase	 400 V	3	11.3	m	
		1500	1500	kg			 230/400V	1200	1200	kg

Reazioni – Reactions – Réactions – Eckdrücke – Reacciones – Reacções

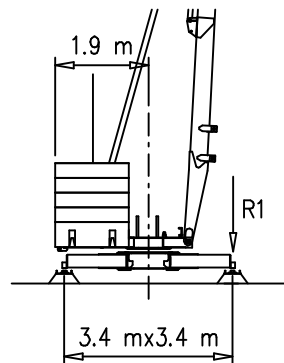

R1 ● 10.5 t ■ 6.9 t
 ▲ 6.8 t ○ 10.6 t

- | | | |
|-------------------------------|---------------------------------------|--------------------------------------|
| ● Reazioni in servizio | ● Reactions in service | ● Réactions en service |
| ■ Reazioni fuori servizio | ■ Reactions out of service | ■ Réactions hors service |
| ▲ Peso della gru senza assali | ▲ Dead weight without transport axles | ▲ Poids de construction sans essieux |
| ○ Peso zavorra rotante | ○ Ballast weight | ○ Poids du lest |
-
- | | | |
|--|--|--|
| ● Reaktionskräfte in betrieb | ● Reacciones en servicio | ● Em serviço |
| ■ Reaktionskräfte außer betrieb | ■ Reacciones fuera de servicio | ■ Fora de serviço |
| ▲ Konstruktionsgewicht ohne transportachse | ▲ Peso de la grua sin tren de transporte | ▲ Peso de grua sem carro de transporte |
| ○ Ballastgewicht | ○ Peso de lastre | ○ Peso de lastre rotativo |

Montaggio – Montage – Erection – Montage – Montaje – Montagem

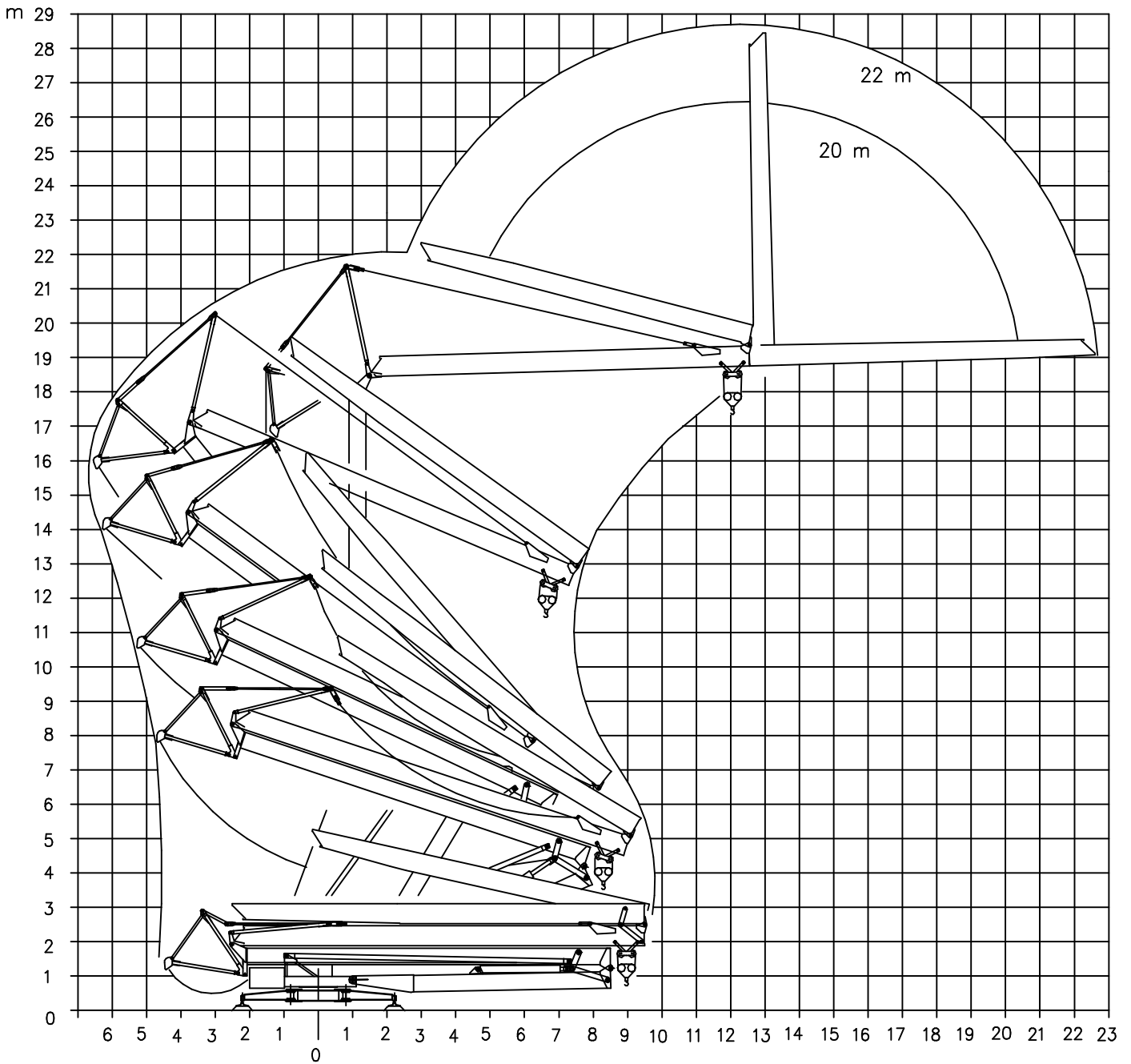

Trasporto – Transport – Transport – Transport – Transporte

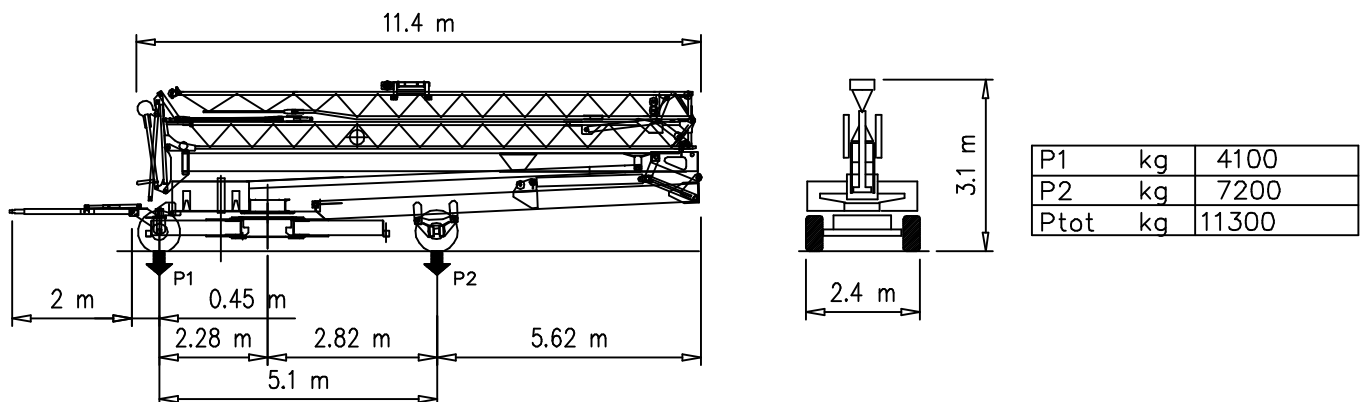

Meccanismi – Mechanisms – Mécanismes – Antriebe – Mecanismos

3 PH	Sollevamento Hoisting Levage Heben Elevaci3n Eleva3o			1a	4 m/min	1500 kg	4 kW
				2a	16 m/min	1500 kg	
				3a	32 m/min	750 kg	
	Carrello Trolleying Distribution Katzfahren Distribuci3n Distribui3o			1a	30 m/min	500 kg	1.85 kW
				1a	15 m/min	1500 kg	
				2a	30 m/min	750 kg	
Rotazione Slewing Orientation Schwenken Orientaci3n Rota3o			giri/min 0.8 tr/min rp/min			1.1 kW	
1/3PH Inverter	Sollevamento Hoisting Levage Heben Elevaci3n Eleva3o	230V		1a	4 m/min	1200 kg	4 kW
				2a	11 m/min	1200 kg	
				3a	25 m/min	600 kg	
				1a	4 m/min	1200 kg	
				2a	16 m/min	1200 kg	
				3a	30 m/min	600 kg	
		400V		1a	4 m/min	1200 kg	
				2a	11 m/min	1200 kg	
				3a	30 m/min	600 kg	
				1a	4 m/min	1200 kg	
				2a	16 m/min	1200 kg	
				3a	30 m/min	600 kg	
	Carrello Trolleying Distribution Katzfahren Distribuci3n Distribui3o			1a	30 m/min	400 kg	1.85 kW
				1a	15 m/min	1200 kg	
				2a	30 m/min	600 kg	
	Rotazione Slewing Orientation Schwenken Orientaci3n Rota3o			giri/min 0.8 tr/min rp/min			1.1 kW

Rete elettrica – Réseau – Mains supply – Netzstrom – Red – Rede electrica	400V – 50 Hz
---	--------------

Potenza elettrica necessaria – Puissance électrique nécessaire Necessary electric power – Anschlusswert – Potencia electrica necesaria	3PH 11 kVA 1/3PH 8 kVA
---	---------------------------

FMgru s.r.l. via Emilia 11-29010 Pontenure PC ITALY tel. 0523/510446 ric.aut. fax 0523/510365 www.fmgru.com e-mail: info@fmgru.com	DIN 15018 2000/14/CE	
---	-------------------------	--



Documento commerciale non contrattuale
Per tutte le informazioni tecniche riferirsi
alle corrispondenti istruzioni

Unverbindliches Vertriebsdokument.
Für technische Informationen, siehe die
entsprechenden Anweisungen.

This commercial document is not legally
binding. For any technical information, please
refer to the corresponding instructions.

Documento comercial no contractual
Para cualquier información técnica,
ver la noticia correspondiente.

Code: 15ICA37B20A0			
Ed.	Data	Rev	Data
1	05.06.03	0	05.06.03