

CRANE DIMENSIONS

RT 780

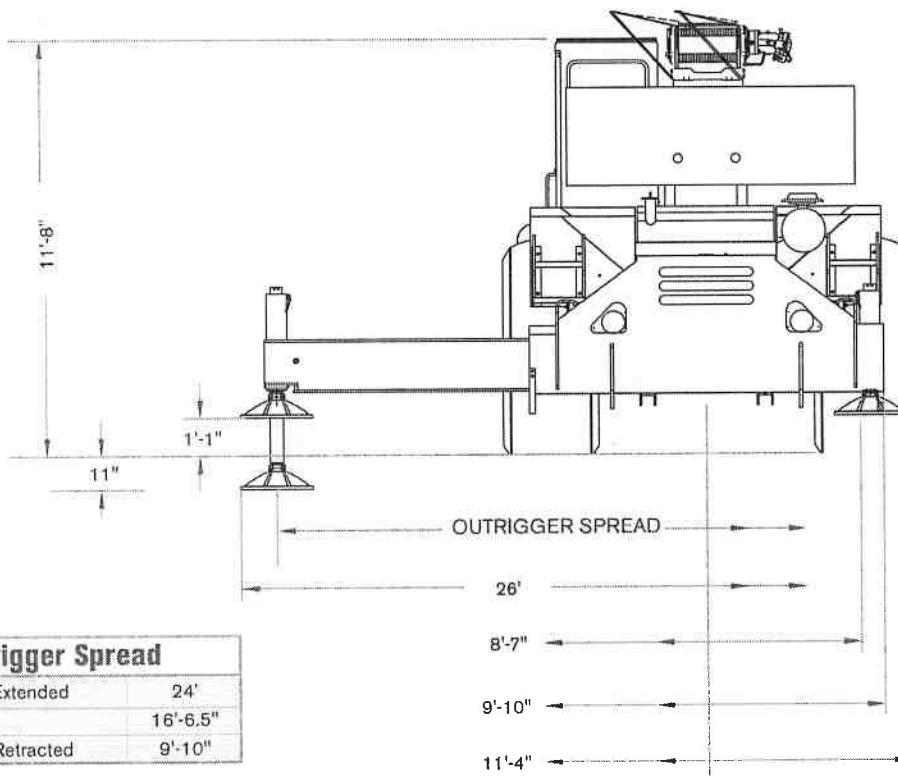
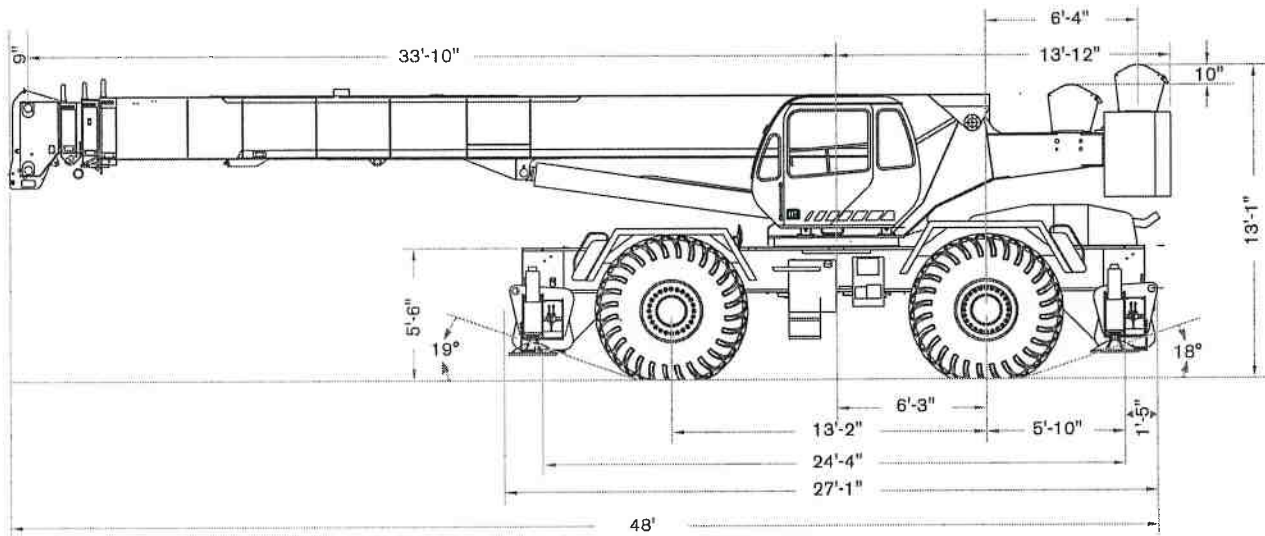

Outrigger Spread	
Fully Extended	24'
Half	16'-6.5"
Fully Retracted	9'-10"

RANGE DIAGRAM - MAIN BOOM

RT 780

Outriggers Fully Extended (100%)



 with hook block:
6 ft 9 in

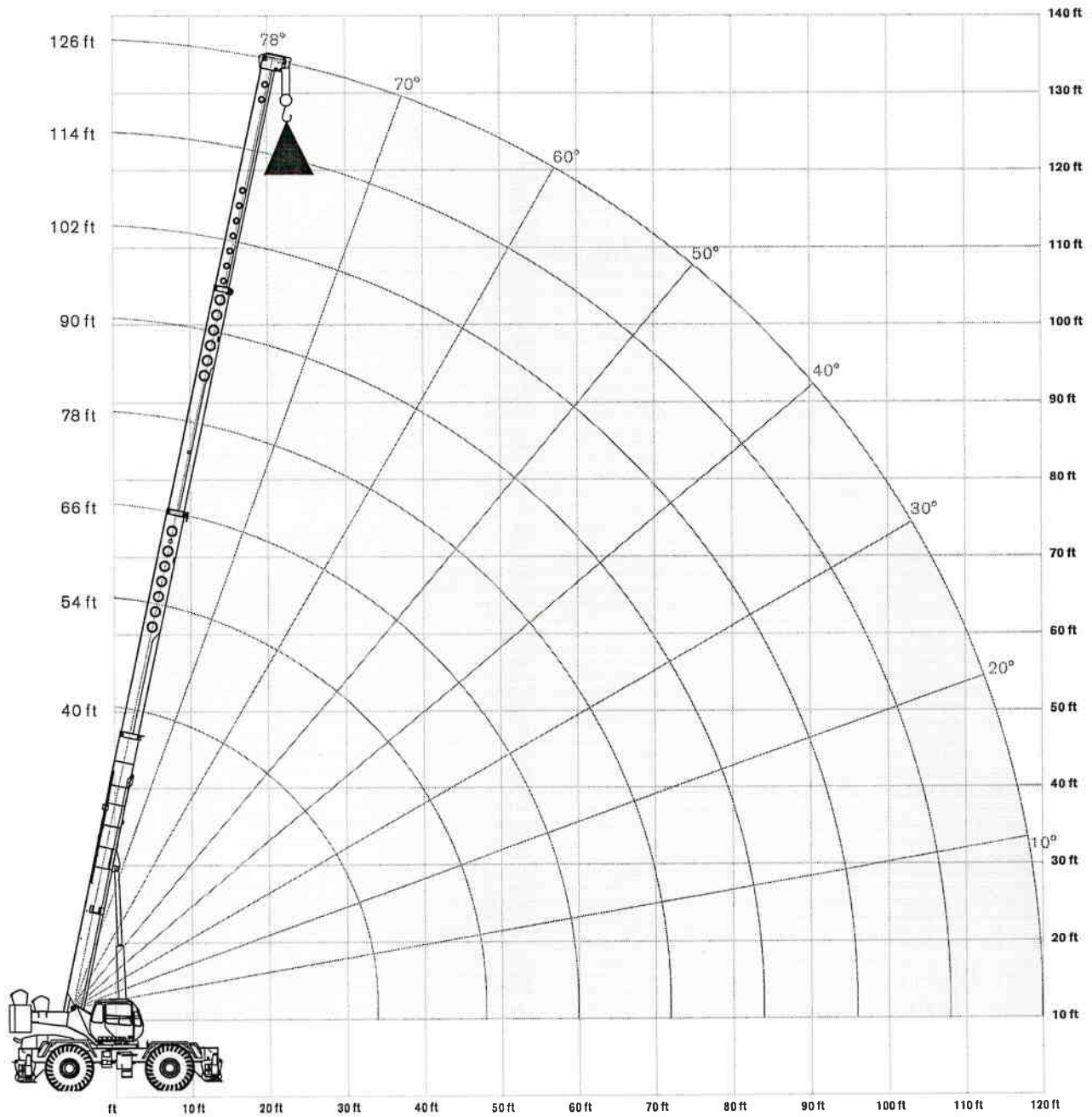

LOAD CHART - MAIN BOOM

RT 780

Outriggers Fully Extended (100%)

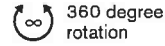
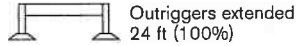
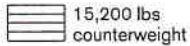

Standard ASME B30.5

ft	Boom Length								ft	
	40 ft	54 ft	66 ft	78 ft	90 ft	102 ft	114 ft	126 ft		
lb	lb	lb	lb	lb	lb	lb	lb	lb	lb	
10	160,000	102,500								10
12	125,600	102,500								12
15	108,800	100,500	80,600							15
20	84,700	85,300	71,900	62,200	56,200					20
25	65,600	66,700	64,800	55,700	48,000	41,900				25
30	49,200	50,500	51,000	49,700	41,700	36,400	31,500			30
35		37,700	38,200	38,500	36,600	32,100	29,500	24,700		35
40		29,400	29,900	30,200	30,400	28,600	26,200	24,600		40
45		23,500	24,100	24,400	24,600	24,700	23,500	22,100		45
50			19,800	20,200	20,300	20,500	20,600	20,000		50
55			16,400	16,900	17,100	17,200	17,300	17,400		55
60				14,200	14,500	14,600	14,700	14,800		60
65				12,100	12,300	12,500	12,600	12,700		65
70				10,300		10,800	10,900	10,900		70
75						9,200	9,400	9,400		75
80						7,900	8,100	8,200		80
85						6,800	6,900	7,100		85
90						5,800	6,000	6,100		90
95						4,900	5,100	5,200		95
100							4,300	4,400		100
105							3,600	3,700		105
110								3,100		110
115								2,500		115

Notes to lifting capacity

Lifting capacities do not exceed 85% of tipping load. Weight of hook blocks and slings is part of the load, and is to be deducted from the capacity ratings. Consult operation manual for further details.

Note: Data published herein is intended as a guide only and shall not be construed to warrant applicability for lifting purposes. Crane operation is subject to the computer charts and operation manual both supplied with the crane.

RANGE DIAGRAM - MAIN BOOM

RT 780



With Jib, 33 ft offset

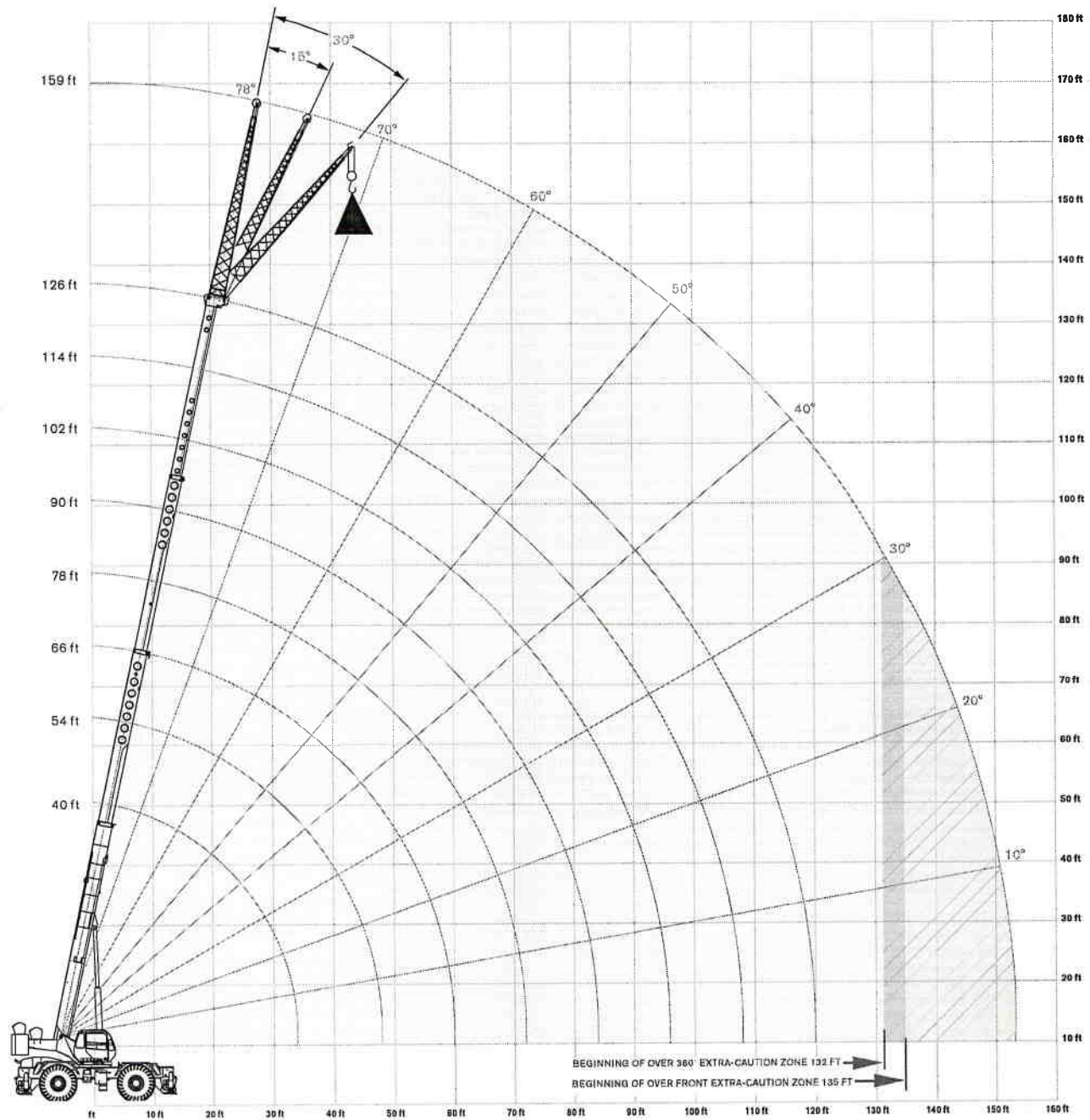
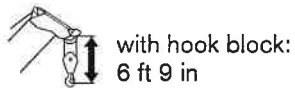



LOAD CHART - MAIN BOOM

RT 780

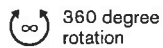
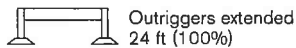
With Jib, 33 ft offset



Standard ASME B30.5

33 ft Offsettable Jib					
0° Offset		15° Offset		30° Offset	
 Radius (ft)	lbs	 Radius (ft)	lbs	 Radius (ft)	lbs
41	12,500	50	8,500	57	6,400
47	12,000	56	8,100	62	6,200
52	11,500	61	7,800	67	6,100
58	10,900	67	7,500	72	5,900
66	9,900	74	7,100	79	5,900
74	9,200	81	6,700	86	5,600
81	8,600	88	6,400	93	5,400
88	7,300	95	6,200	99	5,300
97	5,700	103	5,200	107	5,200
105	4,500	111	4,200	114	4,300
113	3,600	117	3,400	120	3,500
120	2,900	124	2,700	126	2,800
127	2,200	131	2,000	132	1,900
135	1,600	138	1,400	138	1,100

Notes to lifting capacity

Lifting capacities do not exceed 85% of tipping load. Weight of hook blocks and slings is part of the load, and is to be deducted from the capacity ratings. Consult operation manual for further details.

Note: Data published herein is intended as a guide only and shall not be construed to warrant applicability for lifting purposes. Crane operation is subject to the computer charts and operation manual both supplied with the crane.

RANGE DIAGRAM - MAIN BOOM

RT 780

With Jib, 57 ft offset



 with hook block:
6 ft 9 in

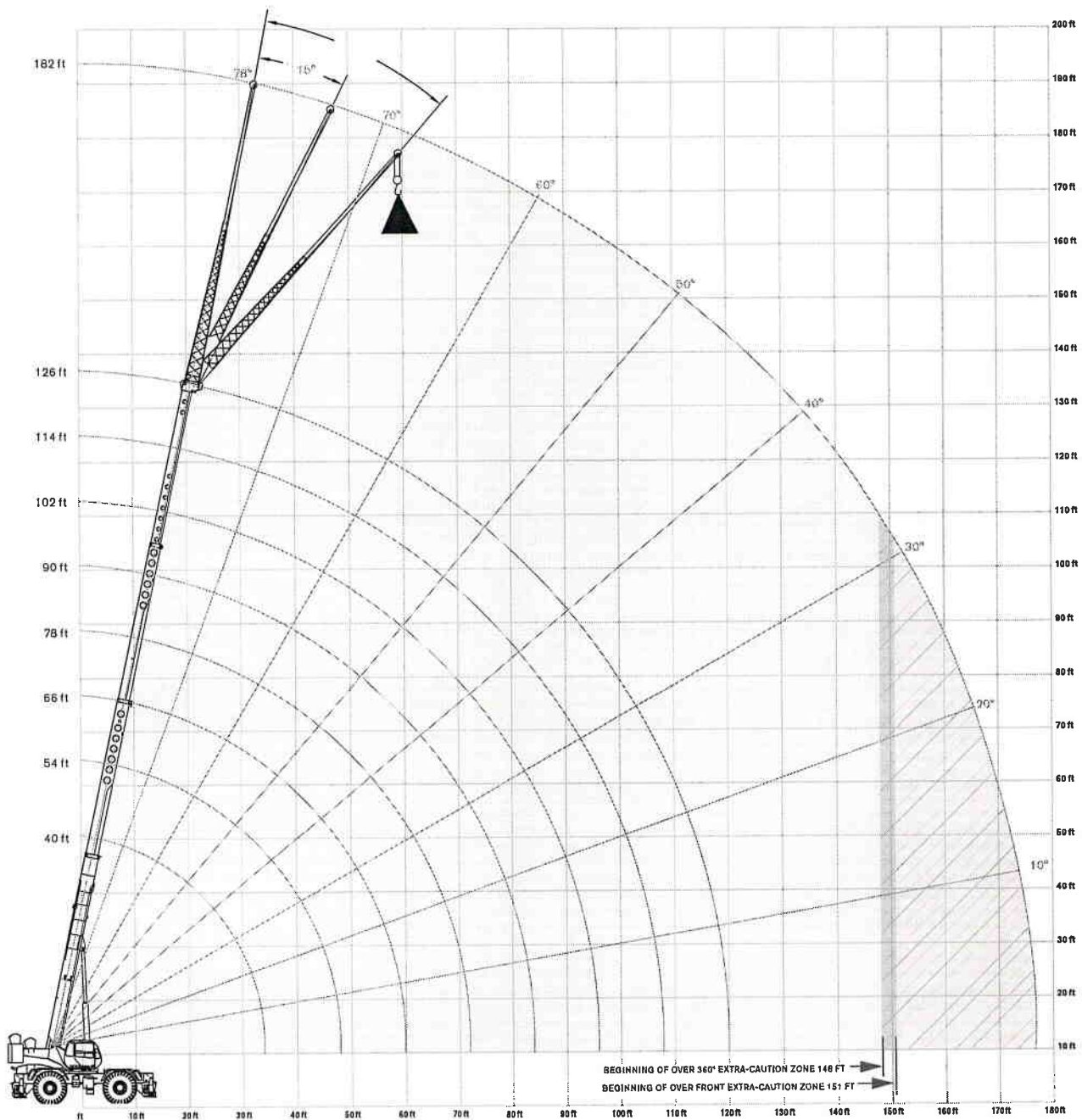



LOAD CHART - MAIN BOOM

RT 780

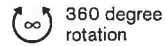
With Jib, 57 ft offset



Standard ASME B30.5

57 ft Offsettable Jib					
0° Offset		15° Offset		30° Offset	
 Radius (ft)	lbs	 Radius (ft)	lbs	 Radius (ft)	lbs
48	6,500	66	4,500	75	3,300
56	6,400	72	4,300	81	3,200
63	6,200	77	4,100	87	3,100
70	6,000	83	3,900	92	3,000
80	5,400	91	3,700	100	2,900
90	4,900	99	3,500	108	2,800
98	4,500	106	3,300	115	2,700
106	4,200	114	3,100	121	2,600
116	3,800	123	2,900	129	2,500
125	3,500	132	2,800	137	2,500
133	2,800	140	2,600	143	2,400
140	2,200	147	2,100	149	2,000
148	1,600	154	1,500	155	1,500
157	1,000	161	1,000	162	1,000

Notes to lifting capacity

Lifting capacities do not exceed 85% of tipping load. Weight of hook blocks and slings is part of the load, and is to be deducted from the capacity ratings. Consult operation manual for further details.

Note: Data published herein is intended as a guide only and shall not be construed to warrant applicability for lifting purposes. Crane operation is subject to the computer charts and operation manual both supplied with the crane.